



CELLGARD^{ES} energy saver

CLASS II, TYPE A2 BIOLOGICAL SAFETY CABINETS



Class II, Type A2 Biological Safety Cabinets

The CellGard Class II Biological Safety Cabinet can be either exhausted back into the room or connected to a facility HVAC system. The cabinet's airflow is 30% exhausted / 70% recirculated to minimize cross-contamination of low to moderate risk biologicals in the absence of volatile toxic chemicals.



NU-480



NU-477



NU-475

Features To Increase Your Productivity

HEPEX™

- Zero Leak Airflow System
- Unidirectional Airflow
- Large HEPA Filters
- Paper-Catch Screen
- Shell / Gaskets Under Negative Pressure
- Front Filter Removal
- Metal Diffuser Over Supply Filter
- Energy Saver DC ECM Motor Technology
- DECON Sealable Window
- Hinged Wing Window
- Framless Sliding Tempered Glass View Screen

EXPERIENCE ERGONOMICS™

- Features for worker comfort and safety
- External Fluorescent Lighting
- 8" or 10" Access Opening at Inflow Velocity of 100 fpm
- Armrest
- Two Outlets (Back Wall)
- Two Service Valves (Right Sidewall)
- Drain Valve

ATTENUMOUNT™

- Vibration and Sound Control System

TOUCHLINK™ (NU-480)

- Electronic Control System



FLOWGARD™ (NU-477)

- Easy Clean Touch Pad Control System



ESSENTIALS (NU-475)

- Easy to Use Toggle Switch Controls



Design Features To Fit Your Individual Applications

- DECON 101 System
- Motorized Auto Window
- Ultraviolet Germicidal Light
- Additional Service Valves for Air, Vacuum, or Gas
- Double (2) Exhaust HEPA Filters
- Remote Service Valves

- Natural Gas Service Valve - Interlocked with Blower
- IV Bar with 6 Stainless Steel Hooks
- ULPA Filters
- Storage Pull-Out Trays
- Heated Work Surface
- Exhaust Transitions

- Base Support Stands
- Sinks with Hot and Cold or DI Water Faucets
- Decorative Side Panels
- Glass Side Walls
- Fume Absorption Carbon Exhaust Filters
- Custom Configurations

Improved Principles of Biological Safety Cabinet Design

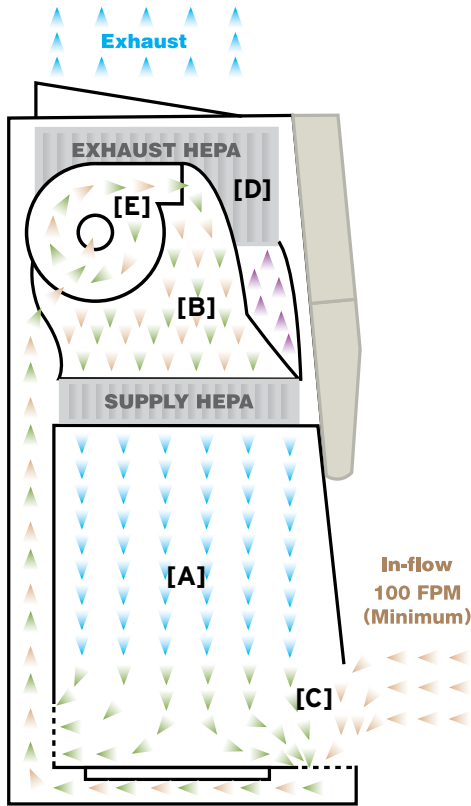

- ▶ HEPA FILTERED AIR
- ▶ CONTAMINATED WORK SURFACE AIR
- ▶ ROOM AIR
- ▶ CONTAMINATED EXHAUST AIR

[A] True Laminar Airflow

Unidirectional airflow moving along parallel flow lines at a constant velocity minimizes air turbulence within the work zone.

[B] HEPEX™ Zero Leak Airflow System

The HEPEX™ Zero Leak Airflow System eliminates the possibility of cabinet and gasket leaks.

[C] Greater Volume of Air Creates a Stronger Air Barrier

Air exchanges within the Class II Biological Safety Cabinet occur 25 times per minute.

[D] Larger, Long Lasting HEPA Filters

NuAire's metal framed HEPA filters are 25% larger than those in competitive products.

[E] Electronically Commutated Motor (ECM)

DC ECM (Electronically Commutated Motor) technology uses electronic controls with brushless DC motors which are inherently more efficient than the currently used permanent-split-capacitor (PSC) motor.

HEPEX™ Zero-Leak Airflow System

NuAire's HEPEX™ Zero Leak Airflow System provides quiet, uniform velocities through the entire sterile work zone. NuAire's system surrounds all positive pressure flow chambers and ducts with vacuum (or negative) air pressure relative to the room. This feature eliminates the possibility of cabinet and gasket leaks. Uneven particulate loading is prevented by maintaining high-static pressure over the entire filter surface.

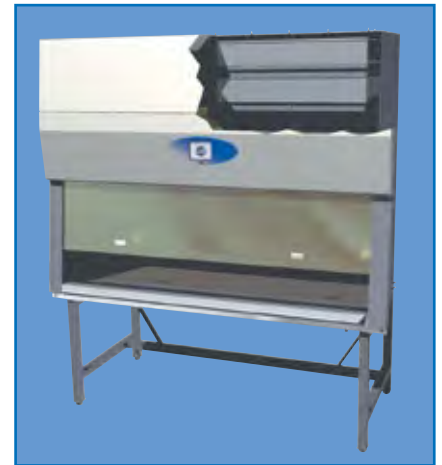
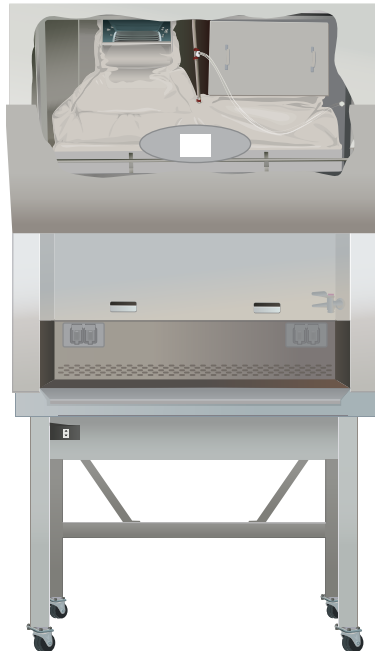

Dual HEPA exhaust filters optional

Cabinet Control Systems



**TOUCHLINK
NU-480**

Features

- Blower Motor Controlled Via Solid State DC Motor Controller
- Monitor, Display and Control Downflow Via Digital Dual Thermistor Airflow Sensor
- Alarm Setpoints, High/Low for Error Conditions (Downflow and Exhaust Flow)
- Remote Alarm Contacts
- Date/Clock Display, and Timer Function
- Control Lights Via Solid State Switch
- Control Outlets Via Solid State Switch
- Perform Complete Diagnostic Functions
- Password Protection

nitecare™- A unique system initiated by the window closure, will reduce motor / blower operational airflow to conserve energy while maintaining work zone sterility. (Configurable)

intelliflow™- Fast, Accurate, Reliable, Dual Thermistor Airflow Sensors powered by TSI. The sensor technology used in certification instruments to assure BSC optimal performance.

Features

- Blower Motor Controlled Via Solid State DC Motor Controller
- Easy to Clean Touch Pad
- On/Off Functions For:
 - Fluorescent Lighting
 - Ultraviolet Germicidal Light
 - Blower/Motor
 - Duplex Outlets
- Monitors Window Position
- Password Protection
- Audible and Visual Alarms
- Remote Alarm Contacts
- **FLOWGARD™** Monitor - Digital Pressure Transducer
 - Green LED- Normal Operation
 - Yellow LED- Caution
 - Red LED- High Alarm Status (HEPA Filter Loading)
 - Low Alarm Status (Low Airflow)

nitecare™ (Configurable)

Features

- Minihelic Pressure Gauge
- DC Motor Controller
- Motor Voltage Regulator
- Audible Window Alarm
- Main & Outlet Power Circuit Breakers
- Power Switch Controls For:
 - Exterior Mounted Fluorescent Lights and/or Ultraviolet Lights
 - Interior Outlets
 - Blower Motor



**FLOWGARD
NU-477**



**ESSENTIALS
NU-475**



CellGard Class II Biological Safety Cabinet

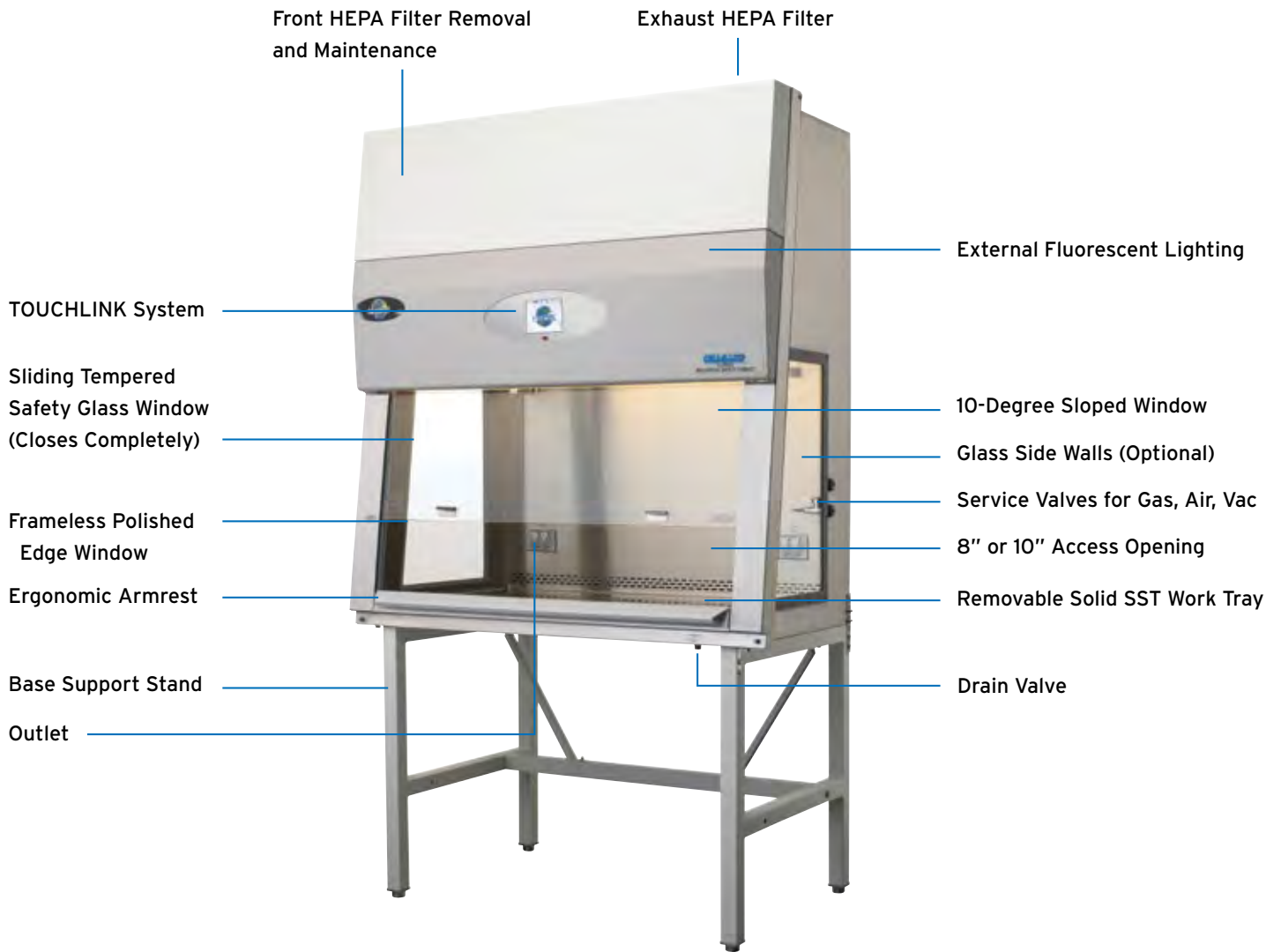

Base Stand Options



Motorized Adjustable Base Stand



Base Stand with Storage Cabinet

Critical Cleaning Components™



critical cleaning components™

Critical Cleaning Components

means the combination of high-quality equipment, proper procedures, and appropriate cleaning aids which combine to help ensure a laboratory environment free from contamination.

Cleaning Aids

Cleaning aids such as the **Mini AlphaMop™** Isolator Cleaning Tool, 12" x 12" **SterileWipe®** and 9" x 9" **AlphaWipe®** Sterile, Low-Particulate wipes help personnel clean effectively.



Equipment Design Features

- Hinged Wing Window Design
- 100% Stainless Steel Interior
- 90% Stainless Steel Overall Construction
- Stainless Steel Grills and Paper Catch
- Removable Stainless Steel Work Tray
- Easy-to-Clean Interior Corners
- Clean Lines- Smooth Surfaces for Effective Cleaning
- Stainless Steel Area Below Work Tray Holds 2 L of Liquid
- Stainless Steel Drain Valve
- Full Metal HEPA Diffuser Protects Filter
- Removable Armrest
- Baked Powder-Coat Polyurethane Paint Finish on Front Panel and Control Center

Cleaning and Disinfecting Process

- Cleaning and disinfecting at the beginning of each shift
- Cleaning and sanitizing the interior between procedures
- Cleaning, rinsing, disinfecting, rinsing, sterilizing after each use

1 Ability to Sit or Stand at a Range of Heights



The cabinet design maximizes knee/thigh clearance to improve posture and the adjustable base stand allows optimization for leg and forearm support.



2 Expanded Vision Zone Reduces Awkward Postures and Proper Lighting Reduces Glare



Cabinets incorporate cool white lighting and frameless polished edge windows to allow for greater visibility and better sight lines.



3 Forearm Support for Comfort and Safety



- Improves forearm support, keeps arms off front air grill
- Closed cell foam, easy to clean



- Closed cell non-absorbing foam
- Disposable, easy application and removal (10 pads / package)

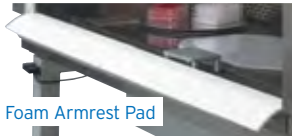

Foam Armrest Pad

4 Larger Effective Work Zone Area

NuAire's cabinets provide the largest effective work zone which helps reduce arm/neck/shoulder strain. Extend reach up to 12" with 100% stainless steel turntable (ball bearing construction, easy to clean and can be autoclaved).



Turntable

5 Ergonomically Designed Laboratory Chair and Footrest

NuAire's BioFit® chair has a star-based platform with adjustable height, back and lumbar support. The non-skid adjustable footrest provides optimal foot/leg support.

BioFit® Chair / Adjustable Footrest



6 Class II Type A2 Cabinet with an Air-Break Canopy Transition*

Class II Type A2 Cabinets with an adjustable base can be canopy connected with the use of Flex Duct and an Air-Break Transition. *Flex Duct necessary if used with adjustable base stand.



Air-Break Canopy Transition

Accessories



Stainless Steel Turn Table

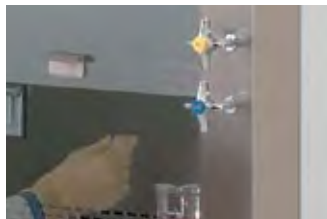

Remote Controlled Service Valves



Adjustable Footrest



BioFit® Ergonomic Adjustable Chair

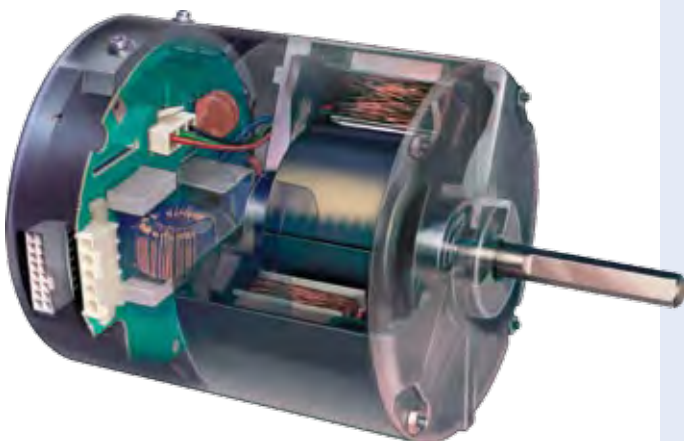

Experience energy savings with DC ECM Technology

NuAire incorporates our existing technology and new DC ECM technology to give you the best VALUE – lower energy costs, longer filter life, and reduced noise and vibration.

Benefits of NuAire cabinets

- Largest HEPA filters with the most pleats per square inch
- Your choice of (3) three different types of control systems
- Internal exhaust damper
- Optimally determined fan for each model size/width

Added benefits from DC ECM technology

- Less energy to operate
- Greater horsepower and lower potential RPM
- Integrated digital control system
- Longer filter life
- Lowest possible noise and vibration
- Ability to upgrade classic AC PSC motor technology in existing cabinets to realize future energy savings

Fan Motor Efficiency

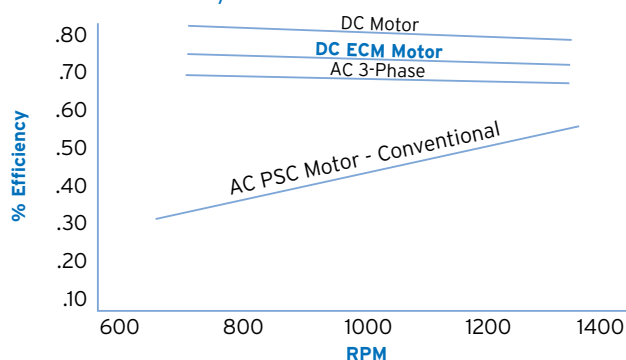

Higher RPMs represent filter loading from particulates in the laboratory.

Filter Loading Capacity

DC ECM technology increases filter life from the NSF minimum requirement of 50% or an approximate 3 year equivalent life to 10 years or more.

Percent increase in total load capacity*:

- 85% - DC (4 Years)
- 180% - AC PSC (7 Years)
- 250% - DC ECM (10 Years)
- 250% - AC 3-Phase (10 Years)

*Percent increase testing based on NSF/ANSI 49, ANNEX A.12 motor/blower performance test methods.

Energy Costs	AC PSC	DC ECM	DC	AC 3-Phase
Kilowatts	.564	.299	.163	.414
KWH	4927	2612	1424	3617
Annual Cost (\$0.09/KWH)*	\$443.43	\$235.09	\$128.16	\$325.53

4 Foot Type A2 BSC that runs 24/7 (8736 hours per year) plus the energy required to control the laboratory ventilation by adding the rejected heat.

* U.S. DOE Average Cost

Noise	AC PSC	DC ECM	DC	AC 3-Phase
Airflow (Design)	N/A	N/A	N/A	N/A
Fan (RPM)	1100-1700	800-1400	1400-2200	800-1400
Motor (Harmonics)	Yes	No	No	No

Vibration	AC PSC	DC ECM	DC	AC 3-Phase
Airflow (Design)	N/A	N/A	N/A	N/A
Fan (RPM)	Higher	Lower	Higher	Lower

Comparison	NuAire DC ECM	NuAire AC PSC	BSC A AC 3-Phase	BSC B DC
8 hrs per day / 5 days per week = 2,000 hrs per year				
KWH per year	598	1128	828	326
\$0.09/kwh	\$54	\$102	\$75	\$29
24 hrs per day / 7 days per week = 8,736 hrs per year				
KWH per year	2612	4927	3617	1424
\$0.09/kwh	\$235	\$443	\$326	\$128
15 Year Life Cycle Costs				
Avg. Filter Changes*	1 Set	2 Sets	1 Set	3 Sets
Estimated Cost of HEPA Filters	\$715	\$1,430	\$715	\$2,145
Total Cost of Decon/Certification	\$450	\$900	\$450	\$1,350
Motors to Replace**	1 Motor	1 Motor	1 Motor	2 Motors
Cost of Motors/ Power Supplies/ Fan Control	\$650	\$420	\$725	\$2,544
Utility Costs (2,000 hrs/yr over 15 years)	\$810	\$1,530	\$1,125	\$435
Total Cost of Ownership	\$2,625	\$4,280	\$3,015	\$6,474

* Estimate (See Filter Load Capacity)

** Estimate based on historical information.

Disclaimer: This example is for illustrative purposes only and should not be deemed a representation of future performance or a guarantee of any kind. Information is based on internal performance data obtained through NuAire® testing and information provided by motor, blower, HEPA filter manufacturers, and independent service technicians.





CellGard ES offers an exclusive system to aid in current decontamination techniques such as Formaldehyde, H₂O₂, or CD systems. The window sash closes completely with the simple removal of the armrest allowing the window to rest on a gasket installed on the inside of the window frame. Window clamps fit securely on the outside of the window to provide the necessary pressure against the gasket for a tight seal. A supply inlet port is provided on top of the cabinet near the blower for the decontaminant introduction. An exhaust seal plate installs over the exhaust filter housing and is locked in place with the use of fasteners. The exhaust seal plate features an exhaust connection port for collection of the decontaminant. Once the decontaminant system has been mounted, the **TOUCHLINK™** Electronic Control System (NU-480 only) features a Decontamination program on screen that aids in the process of decontamination by taking control of blower run times that coincide with the particular decontamination process. The **DECON 101 System** helps streamline the decontamination process providing the service technician with a safe and easy method to protect your laboratory from harmful gases.

DECON Sealable Front Access Window

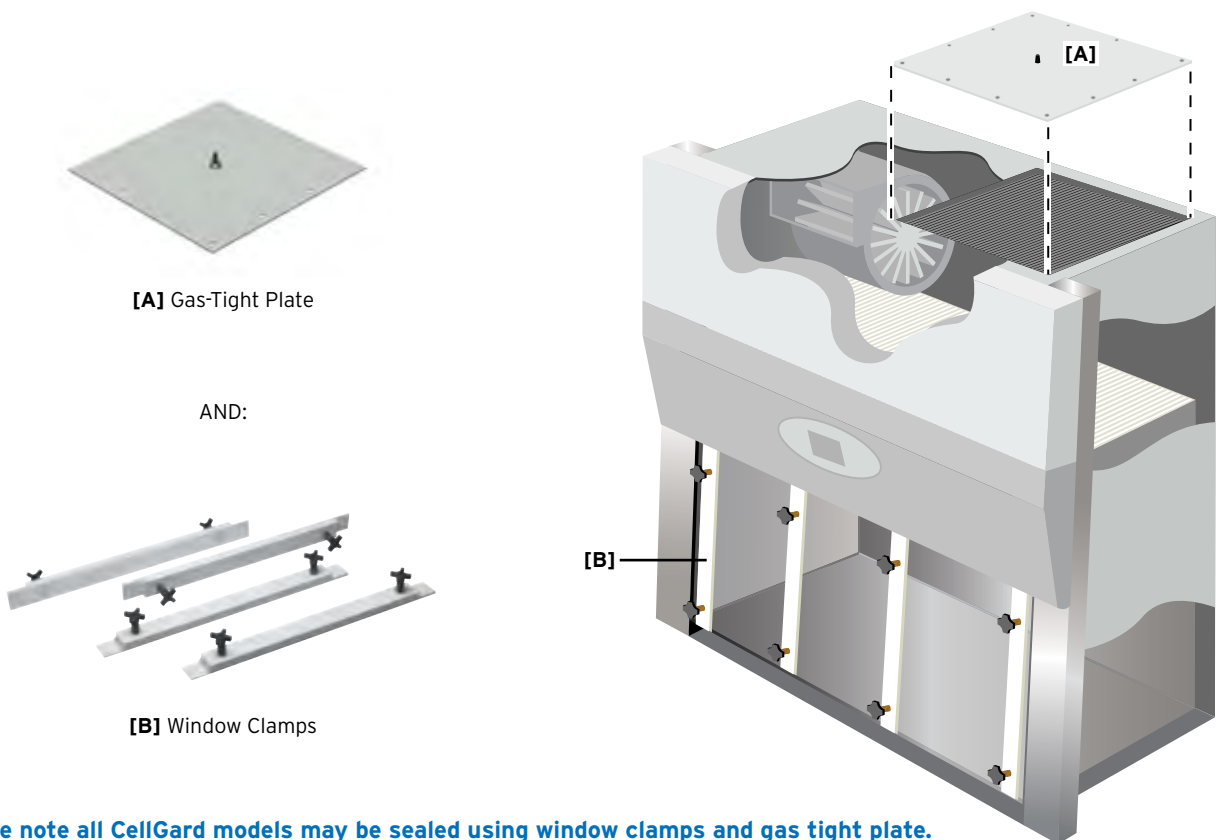

Please note all CellGard models may be sealed using window clamps and gas tight plate.

Specifications

	NU-4XX-300 Nominal 3 ft. [0.9 m]	NU-4XX-400 Nominal 4 ft. [1.2 m]	NU-4XX-500 Nominal 5 ft. [1.5 m]	NU-4XX-600 Nominal 6 ft. [1.8 m]
Style of Cabinet (All Sizes)	All Models: Bench Top / Console with Base Stand / Storage Cabinet			
Cabinet Construction (All Sizes)	All Models: All Welded 16 GA. Type 304 Stainless Steel, Pressure Tight Design			
Diffuser for Air Supply (All Sizes)	All Models: Non-Flammable (Metal)			
HEPA Filter Seal Type Supply Filter 99.995% Eff. on .03 microns Exhaust Filter 99.995% Eff. on .03 microns	All Models: HEPEX™ Seal Neoprene, Springloaded			
Decontamination/Fumigation manual or automated per NSF/ANSI 49 or EN12469	All Models: Yes			
Performance Specifications	All Models: NSF/ANSI 49 and EN12469			
Standard Services Service Coupling (3/8 inch NPT) Outlet	All Models: Two, Right Sidewall Two, Backwall			
Optional Services Gas Cocks (3/8 inch NPT) Remote Controlled Valves** Ultraviolet Light Standard / Cup Sinks	All Models: Up to 3 ea. Sidewall Up to 3 ea. Sidewall One, Backwall Left or Right Work Surface			
Cabinet Size Inches [mm]				
Width	41 ⁵ / ₈ [1057]	53 ⁵ / ₈ [1362]	65 ⁵ / ₈ [1669]	77 ⁵ / ₈ [1972]
Height	61 ⁷ / ₈ [1572]	61 ⁷ / ₈ [1572]	61 ⁷ / ₈ [1572]	61 ⁷ / ₈ [1572]
Depth	33 [664]	33 [664]	33 [664]	33 [664]
(With Control Center and Armrest Removed)				
Work Access Opening Inches [mm]				
Standard Opening Height	8 [196]	8 [196] or 10 [254]	8 [196] or 10 [254]	8 [196] or 10 [254]
Standard Inflow Velocity	105 fpm (0.53 m/s)	105 fpm (0.53 m/s)	105 fpm (0.53 m/s)	105 fpm (0.53 m/s)
Work Zone Inches [mm]				
Width	34 ³ / ₈ [873]	46 ³ / ₈ [1178]	58 ³ / ₈ [1483]	70 ³ / ₈ [1788]
Height	28 ¹ / ₂ [724]	28 ¹ / ₂ [724]	28 ¹ / ₂ [724]	28 ¹ / ₂ [724]
Depth	26 ¹ / ₈ [664]	26 ¹ / ₈ [664]	26 ¹ / ₈ [664]	26 ¹ / ₈ [664]
(Measured at 8 inch Window Height)				
Viewing Window Inches [mm]				
Standard is Safety Plate Sliding Glass	Fully closed to 18 [457] open 8 [196] work access opening	Fully closed to 18 [457] open 8 [196] or 10 [254] work access opening	Fully closed to 18 [457] open 8 [196] or 10 [254] work access opening	Fully closed to 18 [457] open 8 [196] or 10 [254] work access opening
Required Exhaust CFM [CMH] Standard/Optional	8 [203] Opening	10 [254] / 8 [203] Opening	10 [254] / 8 [203] Opening	10 [254] / 8 [203] Opening
Thimble (NU-918 / 817)	282 [479]	438 [739] / 370 [624]	542 [921] / 456 [775]	647 [1100] / 545 [925]
Thimble (NU-916)	306 [519]	462 [783] / 394 [667]	566 [962] / 480 [813]	669 [1139] / 567 [964]
Plant Duct Static Pressure	All Models: .05" - 0.1" [1.27 - 2.54 mm]			
Electrical* (All Sizes)	All Models: 115 VAC / 60 Hz, E : 230 VAC / 50-60 Hz, D : 100 VAC / 50-60 Hz			
Crated Shipping Weight*** lbs. [kg.]	475 [215]	550 [249]	650 [295]	730 [331]
Net Weight lbs. [kg.]	425 [193]	500 [227]	600 [273]	680 [308]
Heat Rejected BTU, Per Hour	8 (203) Opening	10 (254) / 8 (203) Opening	10 (254) / 8 (203) Opening	10 (254) / 8 (203) Opening
Non-Vented	826	1140 / 1020	1768 / 1611	1884 / 1768
Vented	120	157	198	198

* Specify model with appropriate letter suffix for electrical specifications. "NU-475-300E" for 203 VAC / 50 Hz

** Remote controlled valve handles project through faring. Decorative side panels are available to cover plumbing. *** Crated shipping weight does not include weight for accessories or options.

Please note that performance specifications and listings vary for models and types. Please consult NuAire for exact performance specifications and listings. Not all certifications apply to all products.



Exhausting



Variable Flow Exhaust Transition



Canopy Exhaust Transition



Butterfly Valves

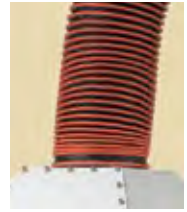

Flex Duct



Exhaust Airflow Monitors



Neoprene Connection Kit



8" to 10" Round Transition

To Locate a NuAire Sales Team Member

Please visit NuAire's Web site at: www.nuaire.com and select the 'Sales Team' menu item. Information can be found there for both United States and international distributors.

www.nuaire.com



Other NuAire Products



AUTOFLOW

CO₂ Incubators



ALLERCARD

Animal Handling Products



GLACIER

ULT Freezers



awel
international

Centrifuges